

SHT4xl-Analog

4th Gen. High-Accuracy, 5V, Industrial Grade

Relative Humidity and Temperature Analog Sensor Platform

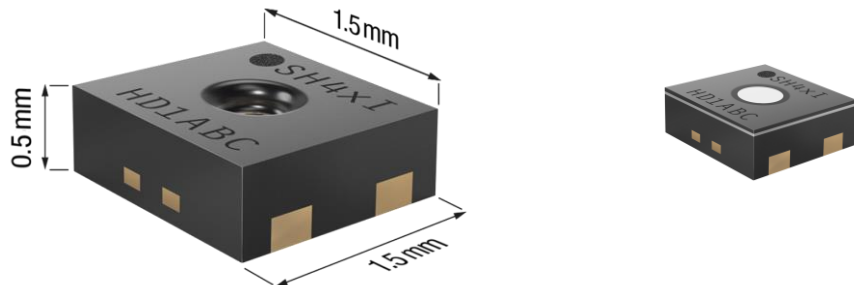

Highlights

- Accuracies $\Delta RH = \pm 2.5\% RH$, $\Delta T = \pm 0.3\text{ }^\circ C$
- Supply voltage VDD = 4.5 V...5.5 V
- Average current: 520 μA
- Analog voltage output 10-90%VDD
- Multiple output characteristics available
- Operating range: 0...100 %RH, -40...125 $^\circ C$
- NIST traceable
- Fully functional in condensing environment
- Variable power heater
- Mature technology from global market leader
- High driver strength
- Patented protection options

Sensors from the SHT4xl-Analog sensor family, currently represented by the SHT40I-Analog, deliver an analog voltage output with several available output characteristics. An optional periodic variable power heater allows for operation in highly demanding environments, such as constant high humidity and condensing atmospheres. The four-pin dual-flat-no-leads package is suitable for surface mount technology (SMT) processing. Options equipped with patented filter membranes and protective covers, enable operation in harshest environments and advanced production processes.

Device Overview

| Product | Details |
|-------------|---|
| SHT40I-HD1B | base RH&T accur., standard ratiometric output characteristic, available in distribution. |
| SHT40I-HD1F | SHT40I-HD1B with PTFE membrane |
| SHT40I-HD1P | SHT40I-HD1B with protective cover |
| SHT40I-xD1B | x: Placeholder for a family of products with base RH&T accur. and customer specific output characteristic |

See full product list on page 16.

Functional Block Diagram

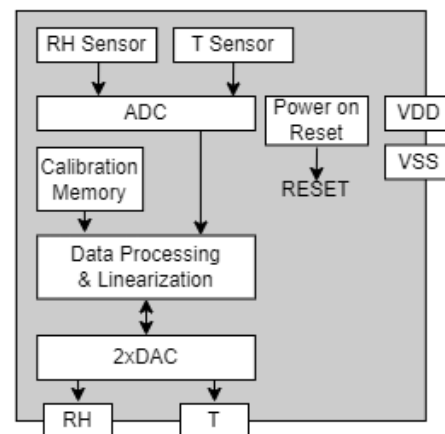

Scan me to provide feedback

Contents

| | | |
|-------|--|----|
| 1 | Sensor Specifications | 3 |
| 1.1 | Relative Humidity | 3 |
| 1.1.1 | Relative Humidity Accuracy at the Extended Temperature Range | 4 |
| 1.2 | Temperature..... | 4 |
| 1.3 | Recommended Operating Conditions..... | 5 |
| 1.4 | Design In..... | 5 |
| 2 | Electrical Specifications | 6 |
| 2.1 | Electrical Characteristics | 6 |
| 2.2 | Timings..... | 6 |
| 2.3 | Absolute Maximum Ratings..... | 7 |
| 3 | Sensor Operation..... | 7 |
| 3.1 | Startup..... | 7 |
| 3.2 | Conversion of the Signal Output | 7 |
| 3.3 | Standard Output Characteristic: SHT40I-HD1B..... | 8 |
| 3.4 | Heater Operation for Anti-Creep Functionality in Highly Demanding Environments | 8 |
| 4 | Physical Specification | 9 |
| 4.1 | Package Description..... | 9 |
| 4.2 | Package Outline | 9 |
| 4.3 | Land Pattern | 10 |
| 4.4 | Pin Assignment & Laser Marking | 11 |
| 4.5 | Thermal Information | 11 |
| 5 | Protection Options..... | 12 |
| 5.1 | Membrane Option | 12 |
| 5.2 | Protective Cover | 12 |
| 6 | Quality and Material Contents | 13 |
| 7 | Tape and Reel Packaging | 13 |
| 8 | Nomenclature | 15 |
| 9 | Ordering Information..... | 16 |
| 10 | Bibliography..... | 16 |
| 11 | Revision History..... | 17 |

1 Sensor Specifications

Every SHT40I-Analog is individually tested, calibrated, and identifiable. For the calibration, Sensirion uses transfer standards, which are subject to a scheduled calibration procedure. The calibration of the reference, used for the calibration of the transfer standards, is NIST traceable through an ISO/IEC 17025 accredited laboratory.

1.1 Relative Humidity

| Parameter | Conditions | Value | Units |
|------------------------------------|-----------------------|--------------|--------|
| SHT40I RH accuracy ¹ | typ. | ±2.5 | %RH |
| | max. | See Figure 1 | - |
| Repeatability ² | typ. | 0.5 | %RH |
| Resolution ³ | - | 0.01 | %RH |
| Hysteresis | At 25°C | ±0.8 | %RH |
| Specified range ⁴ | extended ⁵ | 0 to 100 | %RH |
| Response time ⁶ | $\tau_{63\%}$ | 4 | s |
| Long-term drift ⁷ | typ. | <0.2 | %RH/y |
| Sensitivity (RH range: 0 ... 100%) | VDD = 5.0 V | 40 | mV/%RH |

Table 1. General relative humidity sensor specifications.

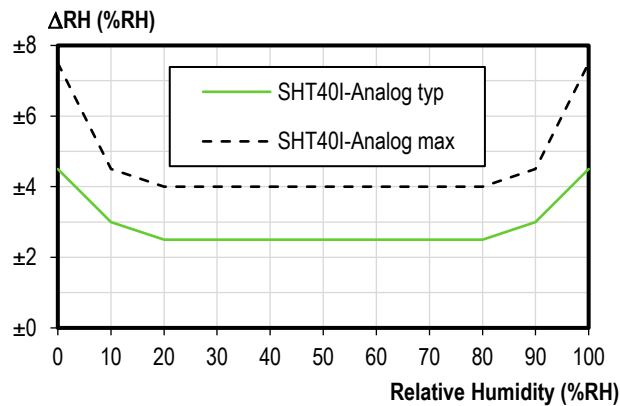

Figure 1. SHT40I-Analog typical and maximal relative humidity accuracy at 25 °C.

¹ For definition of typ. and max. accuracy, please refer to the document “Sensirion Humidity Sensor Specification Statement”.

² The stated repeatability is three times the standard deviation (3σ) of multiple consecutive measurement values at constant conditions and is a measure for the noise on the physical sensor output.

³ Resolution of A/D converter.

⁴ Specified range refers to the range for which the humidity or temperature sensor specification is guaranteed.

⁵ For details about recommended humidity and temperature operating range, please refer to section 1.3

⁶ Time for achieving 63% of a humidity step function, measured at 25 °C and 1 m/s airflow. Humidity response time in the application depends on the design-in of the sensor.

⁷ Typical value for operation in normal RH/T operating range. Value may be higher in environments with vaporized solvents, out-gassing tapes, adhesives, packaging materials, etc. For more details please refer to Handling Instructions.

1.1.1 Relative Humidity Accuracy at the Extended Temperature Range

The typical RH accuracy tolerances in the range of T = 0 °C ... 80 °C are given in Figure 2.

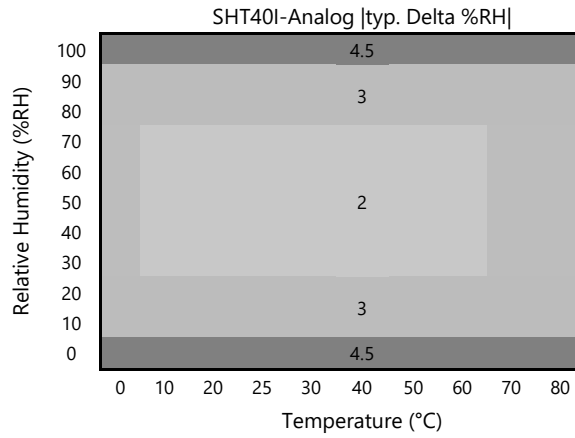

Figure 2. Typical RH accuracy tolerance over humidity and temperature for SHT40xl-Analog.

1.2 Temperature

| Parameter | Conditions | Value | Units |
|--------------------------------|---------------|--------------|-------|
| SHT40I T Accuracy ¹ | typ. | ±0.3 | °C |
| | max. | see Figure 3 | - |
| Repeatability ² | typ. | 0.1 | °C |
| Resolution ³ | - | 0.01 | °C |
| Specified range ⁴ | - | -40 to +125 | °C |
| Response time ⁸ | $\tau_{63\%}$ | 2 | s |
| Long-term drift | typ. | <0.03 | °C/y |
| Sensitivity | VDD = 5.0 V | 23 | mV/°C |

Table 2. General Temperature Sensor specifications.

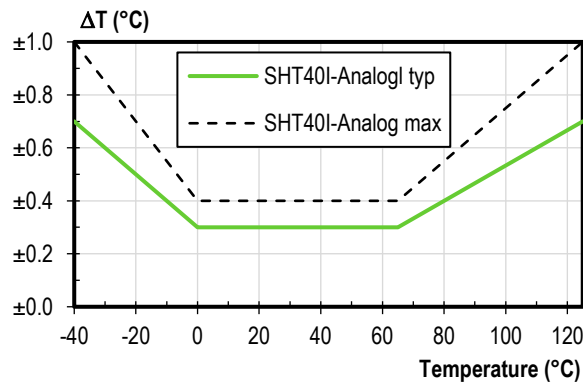

Figure 3. SHT40I analog typical and maximal temperature accuracy.

⁸ Temperature response time depends on heat conductivity of sensor substrate and design-in of sensor in application.

1.3 Recommended Operating Conditions

The sensor shows best performance when operated within the recommended normal temperature and humidity range of 5 °C ... 60 °C and 20 %RH ... 80 %RH, respectively. Long term exposure to conditions outside recommended normal range, especially at high relative humidity, may temporarily offset the RH signal (*e.g.* +3 %RH after 60 h at >80 %RH). After returning into the recommended normal temperature and humidity range the sensor will recover to within specifications by itself. Prolonged exposure to extreme conditions may accelerate ageing.

The Sensors from Sensirions SHT4x Family show exceptional resistance to volatile organic compounds and ageing. To avoid contamination the conditions described in the document "Handling Instructions for humidity Sensors" [2] must be met. Please note that this does apply not only to transportation and manufacturing, but also to operation of the SHT40I.

1.4 Design In

The above-mentioned specifications hold for the stand-alone sensing element. To achieve the best performance and avoid any issues around potential self-heating, please consult the document Design in Guide [1] on our website Sensiron.com.

2 Electrical Specifications

Valid for all electrical specifications: Typical values correspond to $V_{DD} = 5\text{ V}$ and $T = 25\text{ °C}$. Min. and max. values are valid in the full temperature range $-40\text{ °C} \dots 125\text{ °C}$, at declared V_{DD} levels and are based on characterization.

2.1 Electrical Characteristics

| Parameter | Symbol | Conditions | Min | Typ | Max | Unit | Comments |
|--|-----------------------|---------------------|------|-----|-----|---------------|--|
| Supply voltage | V_{DD} | | 4.5 | 5 | 5.5 | V | - |
| Power-up/down level | V_{POR} | Static power supply | 0.75 | 0.9 | 1.0 | V | Above: Communication possible, but measurement value not guaranteed to be in specs (compare supply voltage). Below: System resets completely |
| Slew rate change of the supply voltage | $V_{DD, \text{slew}}$ | | - | - | 20 | V/ms | Voltage changes on the VDD line between $V_{DD, \text{min}}$ and $V_{DD, \text{max}}$ should be slower than the maximum slew rate; faster slew rates may lead to reset |
| Supply current | | Measurement | - | 520 | 850 | μA | At resistive load 1 MOhm |
| Resistive load to VSS | | | 50 | - | - | kOhm | |
| Capacitive load | | | - | - | 100 | nF | |

Table 3. Electrical specifications.

2.2 Timings

Max. values are measured at -40 °C and 1.08 V supply voltage (based on characterization).

| Parameter | Symbol | Conditions | Min. | Typ. | Max. | Units | Comments |
|--------------------------|---------------|---|------|------|------|-------|--|
| Power-up time | t_{PU} | After hard reset, $V_{DD} \geq V_{POR}$ | - | 7 | 15 | ms | Time between V_{DD} reaching V_{POR} and sensor entering idle state |
| Analog out settling time | | | | 200 | | ms | Dependent on band width of the reference path; Value for default setting of BW = 0 (10 Hz) |
| Measurement interval | $t_{MeasInt}$ | Heater disabled. | | 0.5 | | s | With enabled heater refer to Table 6 |

Table 4. System timing specifications

2.3 Absolute Maximum Ratings

Stress levels beyond those listed in **Table 5** may cause permanent damage or affect the reliability of the device. These are stress ratings only and functional operation of the device at these conditions is not guaranteed. Ratings are only tested each at a time.

| Parameter | Rating |
|--|---|
| Max. voltage on any pin | $V_{SS} - 0.3 \text{ V} \dots V_{DD} + 0.3 \text{ V}$ |
| VDD | 6 V |
| Operating temperature range | -40 °C ... 125 °C |
| Storage temperature range ⁹ | -40 °C ... 150 °C |
| ESD HBM | 2 kV |
| ESD CDM | 750 V |
| Latch up, JEDEC Class II, 125°C | ±100 mA |

Table 5. Absolute maximum ratings.

3 Sensor Operation

3.1 Startup

The sensor automatically starts up after reaching the power-up threshold voltage VPOR specified in **Table 3**. After reaching this threshold voltage the sensor needs the time tPU until the first measurement signal is available as voltage output on the respective output pins. During that time the temperature and humidity pins have an undefined state. After sensor startup, the standard measurement interval is 0.5 s (see also **Table 4** and **Table 6**).

3.2 Conversion of the Signal Output

The physical values as measured by the sensor are mapped to a voltage output (VT, VRH as maximum 10 to 90% of VDD).

Prior to conversion into a voltage signal, the physical values are linearized and compensated for temperature and supply voltage effects by the sensor. Additionally, the voltage output is calibrated for each sensor. Hence the relationship between temperature and humidity and the voltage output is the same for each sensor with respect to the output characteristic type, within the limits given by the accuracy (**Table 1** and **Table 2**).

This allows to describe the relationship between physical values (RH and T) and the voltage output for temperature and humidity (VT, VRH) through the formula given in section 3.3.

Please note that some of the RH conversion formulae allow values outside of the range of 0 %RH ... 100 %RH. Relative humidity values which are smaller than 0 %RH and larger than 100 %RH are non-physical; however these "uncropped" values might be found beneficial in some cases (e.g. when the distribution of the sensors at the measurement boundaries are of interest). For all users who do not want to engage in evaluation of these non-physical values, cropping of the RH signal to the range of 0 %RH ... 100 %RH is advised.

For more information about different output characteristics, please get in touch with info@sensirion.com.

⁹ The recommended storage temperature range is 10-50 °C. Please consult the document "SHTxx Handling Instructions" [2] for more information.

3.3 Standard Output Characteristic: SHT40I-HD1B

$$RH = \left(-12.5 + 125 \cdot \frac{V_{RH}}{V_{DD}} \right) \%RH = -\frac{10}{0.8} + \frac{100}{0.8} \cdot \frac{V_{RH}}{V_{DD}} \%RH \quad (1)$$

See Figure 4

$$T = \left(-66.875 + 218.75 \cdot \frac{V_T}{V_{DD}} \right) ^\circ C = -45 - \frac{17.5}{0.8} + \frac{175}{0.8} \cdot \frac{V_T}{V_{DD}} ^\circ C \quad (2)$$

$$T = \left(-88.375 + 393.75 \cdot \frac{V_T}{V_{DD}} \right) ^\circ F = -49 - \frac{31.5}{0.8} + \frac{315}{0.8} \cdot \frac{V_T}{V_{DD}} ^\circ F \quad (3)$$

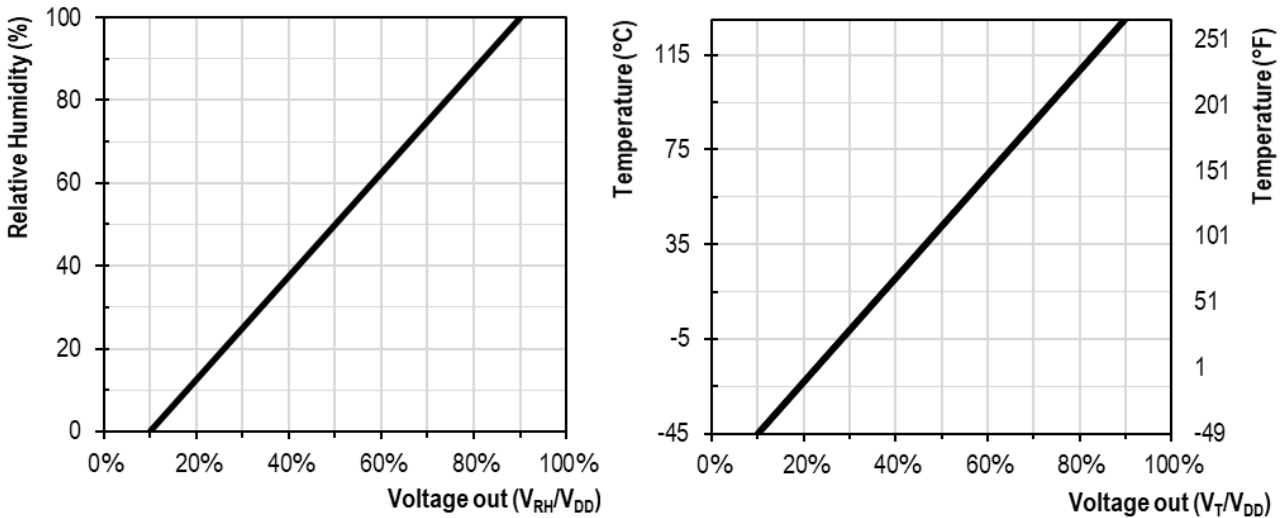

Figure 4. Relationship between the analog voltage output and the measured relative humidity and temperature corresponding to equations (1) (2) & (3)for the SHT40I-HD1B.

3.4 Heater Operation for Anti-Creep Functionality in Highly Demanding Environments

Operation of any humidity sensor in high humidity or condensing environments for extended periods of time and/or at high temperature, increases the risk for gradual incorporation of excess water into the sensor element, which in turn leads to overestimated humidity, commonly denoted as sensor creep. Sensirion’s SHT4x generation is already the most creep-resistant sensor on the market, due to extensive research and material optimization. However, creep can never be fully suppressed due to physico-chemical material limitations of all known polymers. In order to circumvent this issue, the SHT4x generation features a powerful integrated on-chip heater, that allows for creep reduction by removing excess water, when necessary.

While the digital models of the SHT4x family feature user-selectable heating modes, the analog version comprises an optional factory-set periodical heater, keeping the sensor element in mint state during all, no matter how demanding, operation modes. The periodic heating-measurement cycle proceeds according to the following steps:

1. The heater is enabled with pre-defined power (up to 200 mW) and timer (up to 2 s) according to Table 6. The timers for the measurement interval ($t_{MeasInt}$) and the heater-on duration (t_{Heat}) are started.
2. After the heater is turned off, the sensor remains in idle mode for $t_{MeasInt} - t_{Heat}$. When defining the timing specifications, customers must ensure to not select combinations where $t_{MeasInt} < t_{Heat}$, which would result in impaired measurements.
3. After $t_{MeasInt}$ is reached, a humidity and temperature measurement is started and the cycle starts from the beginning

The heater configuration is a factory setting and can be ordered with the following parameters:

| Parameter | Selectable Values |
|--|--|
| Heater Power | 0 (=off), 100, 150, 200 mW |
| Heater-on Duration (t_{Heat}) | 0.1, 0.5, 1, 2 s $\pm 15\%$ |
| Measurement Interval ($t_{MeasInt}$), if heater is enabled, otherwise: 0.5 s | 0.5, 15, 30, 45, 60, 75, 90 s $\pm 15\%$ |

Table 6. Possible SHT4xl-analog heater parameters configurations.

Possible Heater Use Cases

There will be dedicated Sensirion application notes elaborating on various use cases of the heater. In general, the applications of the on-chip heater comprise:

1. Removal of condensed / spray water on the sensor surface. Although condensed water is not a reliability / quality problem to the sensor, it might make the sensor non-responsive to RH changes in the air as long as there is liquid water on the surface.
2. Creep-free operation in high humid environments. Periodic heating pulses allow for creep-free high-humidity measurements for extended times.

4 Physical Specification

4.1 Package Description

The SHT4xl-Analog is provided in an open-cavity dual flat no lead (DFN) package. The humidity sensor opening is centered on the top side of the package. The sensor chip is made of silicon, hosted on a copper lead frame and overmolded by an epoxy-based mold compound. Exposed bottom side of the leadframe with the metallic contacts is Ni/Pd/Au coated, side walls are bare copper. Moisture sensitivity level (MSL) of 1 according to IPC/JEDEC J-STD-020 is achieved. It is recommended to process the sensors within one year after date of delivery.

4.2 Package Outline

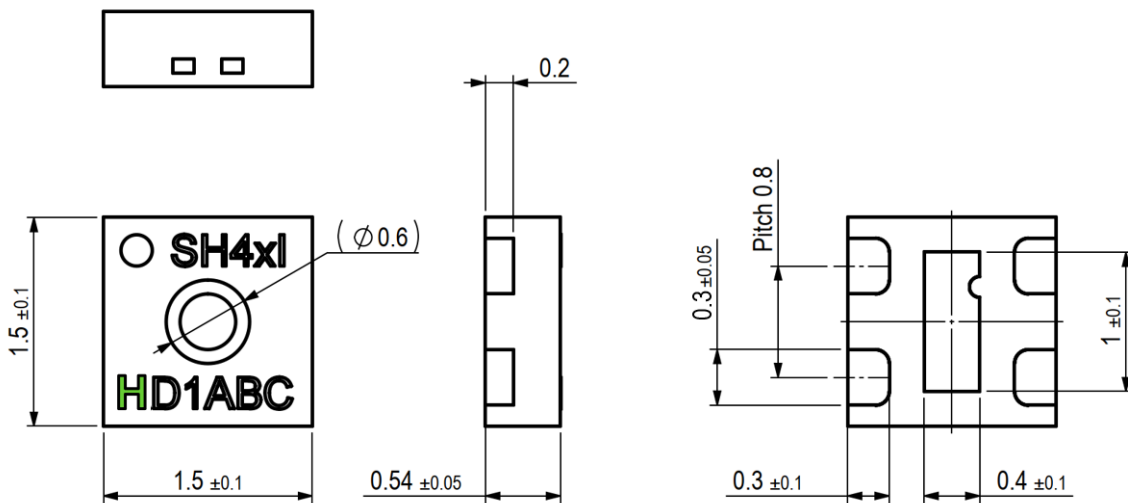

Figure 5. Dimensional drawing of SHT4xl-Analog including package tolerances (units mm), where the H (here highlighted in green for better identification) serves as indicator for the standard analog interface. Other letters alphabetically after the letter H, indicate other versions of the analog interface.

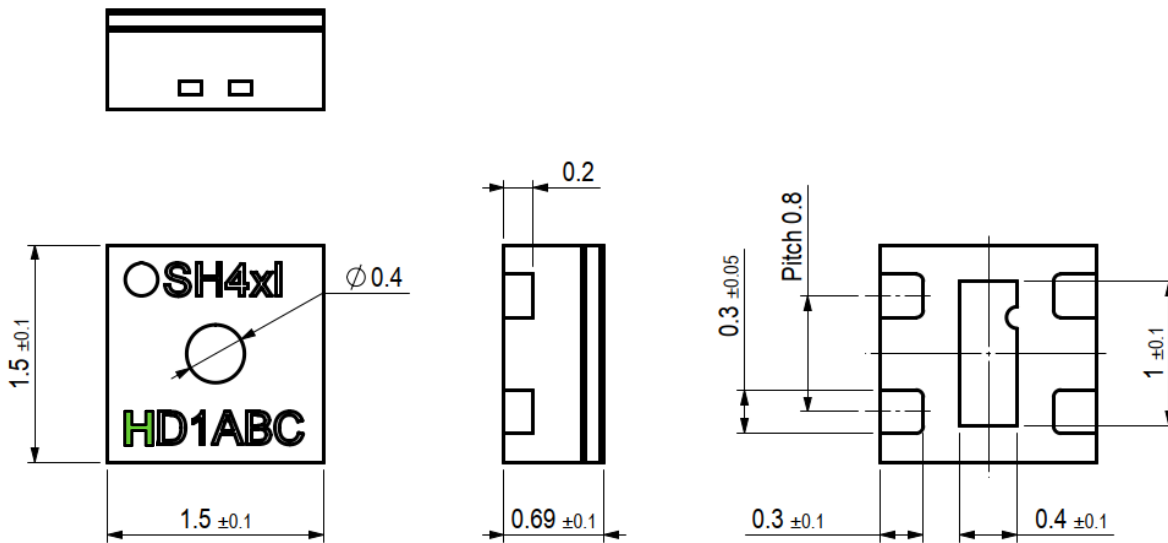

Figure 6. Dimensional drawing of SHT4xl-Analog with filter membrane, including package tolerances (units mm).

4.3 Land Pattern

The land pattern is recommended to be designed according to the used PCB and soldering process together with the physical outer dimensions of the sensor. For reference, the land pattern used with Sensirion’s PCBs and soldering processes is given in **Figure 7**. Soldering of the central die pad, as well as an exposed copper pad underneath it, is not recommended by Sensirion due to it acting as a heat sink which prevents the heater from functioning according to its specifications.

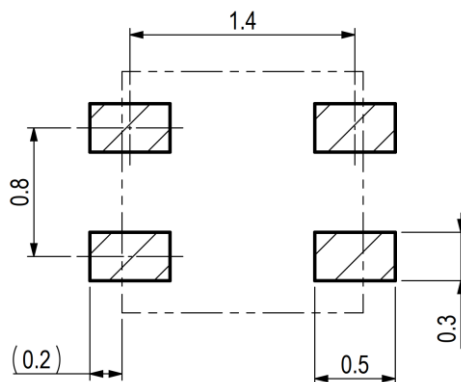

Figure 7. Recommended land pattern (in mm). Details can vary and depend on used PCBs and solder processes. There shall be no copper under the sensor other than at the pin pads.

4.4 Pin Assignment & Laser Marking

| Pin | Name | Comments |
|-----|---------|----------------|
| 1 | AOUT-RH | Analog Out RH |
| 2 | AOUT-T | Analog Out T |
| 3 | VDD | Supply voltage |
| 4 | VSS | Ground |

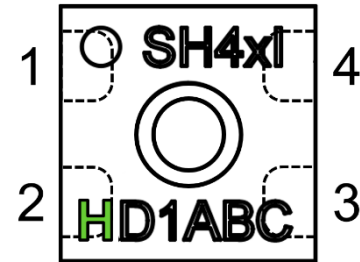

Figure 8. Pin assignment (transparent top view). Dashed lines are only visible if the sensor is viewed from below. The die pad is not directly connected to any pin.

The laser marking consists of two lines, indicated in **Figure 5** & **Figure 8**. In the first line a filled circle serves as pin-1 indicator and is followed by “SH4”. The fourth character will indicate the accuracy class of this product (here “x” serves as place holder). Lastly, “1” indicates the industrial grade. In the second line, the first three characters specify the product characteristics according to positions 7, 8 and 9 of **Table 8**. The second three characters serve as internal batch tracking code.¹⁰

4.5 Thermal Information

| Symbol | Description | Heater off, die pad soldered (K/W) | Heater on, die pad soldered (K/W) | Heater off, die pad not soldered (K/W) | Heater on, die pad not soldered (K/W) |
|-----------------|---|------------------------------------|-----------------------------------|--|---------------------------------------|
| $R_{\theta JA}$ | Junction-to-ambient thermal resistance | 246 | 308 | 297 | 357 |
| $R_{\theta JC}$ | Junction-to-case thermal resistance | 189 | 255 | 191 | 257 |
| $R_{\theta JB}$ | Junction-to-board thermal resistance | 159 | 225 | 193 | 258 |
| Ψ_{JB} | Junction-to-board characterization param. | 159 | 223 | 191 | 254 |
| Ψ_{JT} | Junction-to-top characterization param. | 38 | 105 | 44 | 112 |

Table 7. Typical values for thermal metrics. In the “heater on” columns a heater power of 200 mW was assumed. Soldering of the die pad is not recommended, therefore the two right hand side columns are bold. Values are based on simulation.

¹⁰ Please note, there will be no change in the laser marking for the protective option (filter membrane and protective cover).

5 Protection Options

5.1 Membrane Option

The filter membrane option for SHT4x family members inherently provides an additional barrier for all pollutants to enter the sensor opening, thus lowering negative influences on the sensing element. Mostly designed to keep particles and dust from accumulating and reducing the response time, the membrane also enables more efficient and easy cleaning, as it helps to reduce liquid intrusion into the sensor opening. Even though not selectively filtering, in general, physical barriers allow to reduce the amount of unwanted chemical contamination and help to remove potentially harmful components by facilitating wiping (flat sensor surface).

The integrated PTFE membrane provides additional protection from particles and enables sensor operation in harsh conditions (according to IP67). The membrane has a thickness of 100 μm offering a filtration efficiency of >99.99% for particles of 200 nm size and larger. Owing to the high permeability and the small volume between sensing element and membrane, the specified response time of the RH sensor is unaltered.

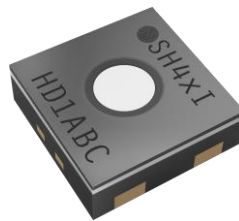

Figure 9. SHT4xI-Analog with integrated PTFE membrane, highlighting the beneficial flat geometry of the SHT4xI-Analog.

To ensure full functionality of the sensor and avoid damaging its integrated filter membrane, when mounting the sensor, follow the reflow soldering process as described in the Handling Instructions [2]. Furthermore the therein described care regarding board wash and cleaning still apply.

5.2 Protective Cover

The SHT4xI-Analog will be available with a second protective option, a removable protective cover to protect the sensing element during sensor installation. The sensor will be delivered with the protective cover attached such that the sensor opening is completely covered and sealed. This enables cost-effective brush-over and spray-over application procedures of conformal coating material. Such coating is often required in highly corrosive environments to protect solder joints. In this process the protective cover prevents the sensor opening from being sealed by any coating. Afterwards the protective foil can safely be pulled off with tweezers at the designated non-sticking flap which contains the anti adhesion layer.

The protective cover is made of polyimide making it highly resistant to chemicals and elevated temperatures. To ensure full functionality of the cover, when mounting the sensor, follow the reflow soldering process as described in the Handling Instruction [2].

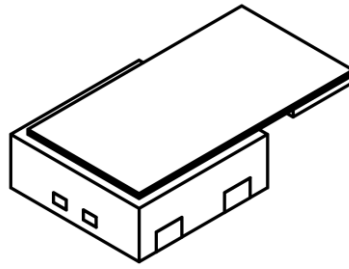

Figure 10. Sketch of the SHT4xI-Analog with attached polyimide foil.¹¹

6 Quality and Material Contents

Qualification of SHT4xI-Analog is performed based on the JEDEC JESD47 qualification test method. Qualification report available on request. The device is fully RoHS and WEEE compliant, e.g. free of Pb, Cd, and Hg.

For general remarks of best practice in processing humidity sensor please refer to the handling instructions [2].

7 Tape and Reel Packaging

All specifications for the tape and reel packaging can be found on Figure 11. Reel diameters are 13 inch and 7 inch for the 10k and the 2.5k packaging sizes, respectively.

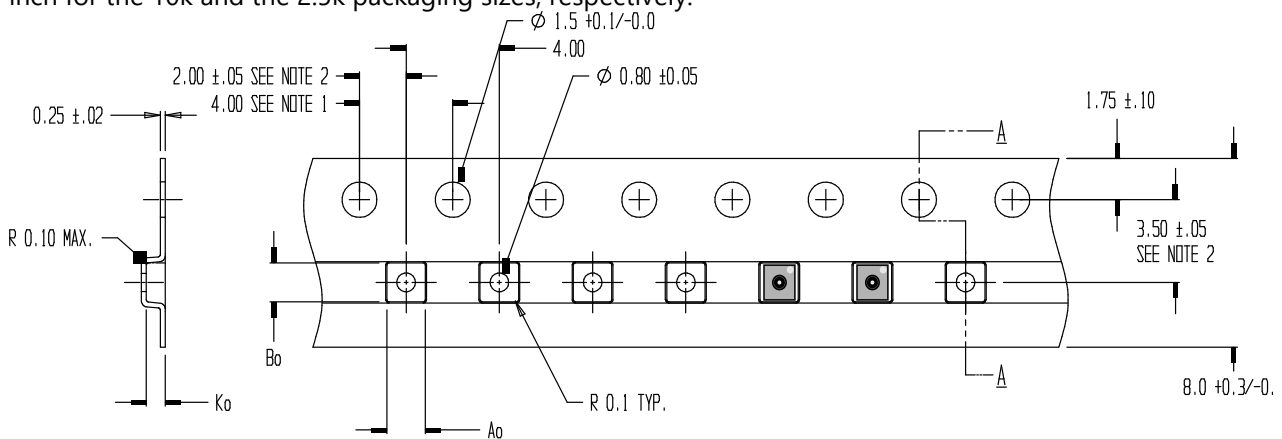

NOTES:

1. 10 SPROCKET HOLE PITCH CUMULATIVE TOLERANCE ± 0.2
2. POCKET POSITION RELATIVE TO SPROCKET HOLE MEASURED AS TRUE POSITION OF POCKET, NOT POCKET HOLE
3. A_0 AND B_0 ARE CALCULATED ON A PLANE AT A DISTANCE "R" ABOVE THE BOTTOM OF THE POCKET.

$A_0 = 1.65 \pm 0.05$
 $B_0 = 1.65 \pm 0.05$
 $K_0 = 0.81 \pm 0.05$

TOLERANCES - UNLESS NOTED 1PL ± 0.2 2PL ± 0.10

Figure 11. Tape and reel specifications including sensor orientation in pocket (see indication of two sensors on the right side of the tape).

¹¹ This a preliminary sketch only and might be subject to change.

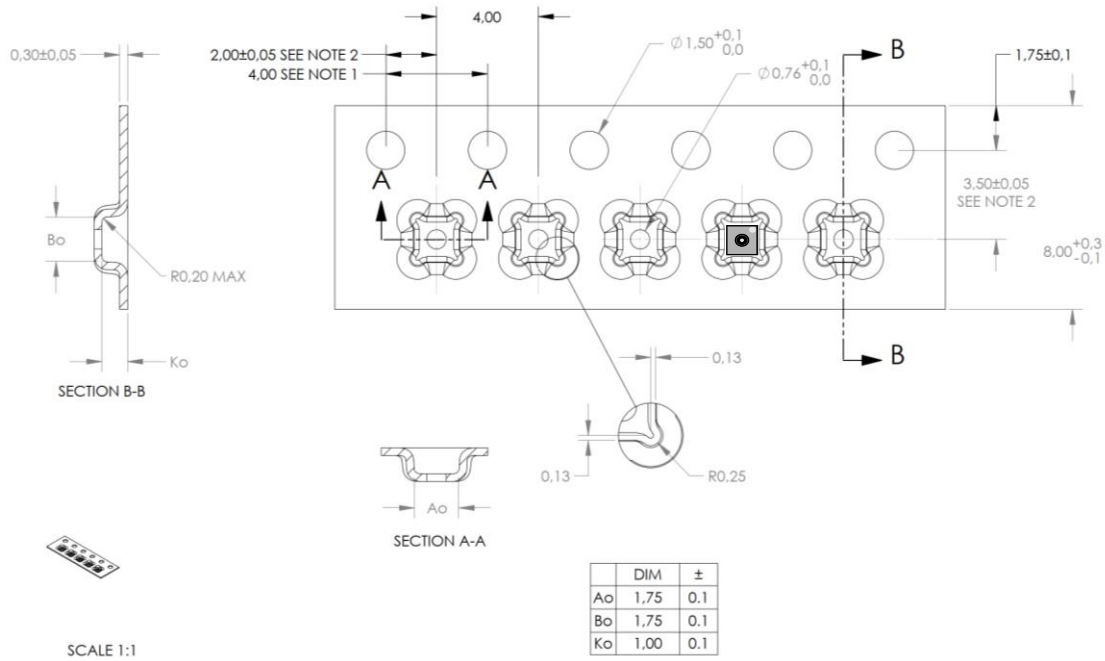

NOTES:

1. 10 SPROCKET HOLE PITCH CUMULATIVE TOLERANCE ±0,2
2. POCKET POSITION RELATIVE TO SPROCKET HOLE MEASURED AS TRUE POSITION OF POCKET, NOT POCKET HOLE.
3. Ao AND Bo ARE MEASURED ON A PLANE AT A DISTANCE "R" ABOVE THE BOTTOM OF THE POCKET.

Figure 12. Tape and reel specification of the including sensor orientation in pocket of sensor with membrane option.

8 Nomenclature

| Position | Value(s) | Explanation |
|----------|----------|--|
| 1 | S | Sensirion |
| 2 | H | Humidity Signal |
| 3 | T | Temperature Signal |
| 4 | 4 | Fourth product generation |
| 5 | 0 | Base accuracy |
| 6 | I | Industrial version |
| 7 | - | delimiter |
| 8 | H ... | Standard ARP analog output characteristic custom/application specific output characteristic |
| 9 | D | DFN package |
| 10 | 1 | Reserved |
| 11 | B | Blank package |
| | F | Package with integrated, patented PTFE membrane |
| | P | Package with removable protective cover for conformal coating (coming soon) |
| 12 | - | delimiter |
| 13 | R | Tape on reel packaging |
| 14 | 2 | Packaging article contains 2'500 pieces |
| | 3 | Packaging article contains 10'000 pieces |

Table 8. SHT4xl-Analog product nomenclature. For ordering information, kindly refer to **Table 9**.

9 Ordering Information

| Material Description | Material Number | Details | Quantity (pcs) |
|----------------------|-----------------|--|----------------|
| SHT40I-HD1B-R2 | 3.000.636 | base RH&T accuracy, standard ARP analog output characteristic | 2'500 |
| SHT40I-HD1F-R2 | 3.000.889 | base RH&T accuracy, standard ARP analog output characteristic including patented PTFE membrane | 2'500 |
| SHT40I-HD1P-R2 | tbd | base RH&T accuracy, standard ARP analog output characteristic including removable protective cover | 2'500 |
| SHT40I-HD1B-R3 | Upon request | base RH&T accuracy, standard ARP analog output characteristic | 10'000 |
| SHT40I-xD1B-R3 | Upon request | base RH&T accuracy, application specific analog output characteristic | 10'000 |

Table 9. SHT4xl-Analog ordering options.

Sensor evaluation kits are only available for SHT40I-HD1B. Please note that the Sensirion Sensor Bridge only allows read-out of the RH parameter, since it only features one analog pin.

10 Bibliography

- [1] Sensirion, "SHTxx Design Guide".
- [2] Sensirion, "Handling Instructions for Humidity Sensors," 2020.

11 Revision History

| Date | Version | Pages | Changes |
|----------------|---------|---|--|
| September 2021 | 0.1 | all | First preliminary version |
| December 2021 | 0.2 | 1, 6-10 5 3, 4 12, 13 13 15, 16 | Added multiple output characteristics Adapted electrical specifications and timings Added accuracy plots Updated package outline and land pattern Added pin assignment information Extended product nomenclature and ordering information |
| September 2022 | 1 | all | Updated accuracy plots, article numbers, and wording changes. |
| December 2022 | 2 | 1 1 7 10 11 12 14 16 all all | Updated Device Overview with membrane options Added Feedback QR code Corrected typo in ESD HBM Inserted Figure 6 about filter membrane dimensions Footnote 10: No change in laser marking of protective options Added Section 5 on protective options Inserted Figure 12 tape/reel specs of membrane option Updated ordering information in Table 9 . Reviewed font size, typos, references & general formatting Removed multiple output characteristics and made individual Datasheets for each |
| Mai 2023 | 2.1 | 1 8 | Correction of Functional Block diagram – removal of nReset Corrected Typo in Eq. (3) (°F instead of °C) |
| August 2023 | 3 | all 5 12, 13 | Reformatting into new Sensirion DS Design and typo correction Inserted reference to Design-in guide, section 1.4 Switched order of section 5 and 6 |
| October 2023 | 3.1 | Multiple 4 5 9 12 | Updated Bibliography and respective references Added Section on extended RH accuracy Edited ageing and voc subsection Updated caption in Table 6 Mentioned anti adhesion layer |
| February 2024 | 3.2 | 6 | Adapted minimum resistive load |

Important Notices

Warning, Personal Injury

Do not use this product as safety or emergency stop devices or in any other application where failure of the product could result in personal injury. Do not use this product for applications other than its intended and authorized use. Before installing, handling, using or servicing this product, please consult the data sheet and application notes. Failure to comply with these instructions could result in death or serious injury.

If the Buyer shall purchase or use SENSIRION products for any unintended or unauthorized application, Buyer shall defend, indemnify and hold harmless SENSIRION and its officers, employees, subsidiaries, affiliates and distributors against all claims, costs, damages and expenses, and reasonable attorney fees arising out of, directly or indirectly, any claim of personal injury or death associated with such unintended or unauthorized use, even if SENSIRION shall be allegedly negligent with respect to the design or the manufacture of the product.

ESD Precautions

The inherent design of this component causes it to be sensitive to electrostatic discharge (ESD). To prevent ESD-induced damage and/or degradation, take customary and statutory ESD precautions when handling this product. See application note "ESD, Latchup and EMC" for more information.

Warranty

SENSIRION warrants solely to the original purchaser of this product for a period of 12 months (one year) from the date of delivery that this product shall be of the quality, material and workmanship defined in SENSIRION's published specifications of the product. Within such period, if proven to be defective, SENSIRION shall repair and/or replace this product, in SENSIRION's discretion, free of charge to the Buyer, provided that:

- notice in writing describing the defects shall be given to SENSIRION within fourteen (14) days after their appearance;
- such defects shall be found, to SENSIRION's reasonable satisfaction, to have arisen from SENSIRION's faulty design, material, or workmanship;
- the defective product shall be returned to SENSIRION's factory at the Buyer's expense; and
- the warranty period for any repaired or replaced product shall be limited to the unexpired portion of the original period.

This warranty does not apply to any equipment which has not been installed and used within the specifications recommended by SENSIRION for the intended and proper use of the equipment. EXCEPT FOR THE WARRANTIES EXPRESSLY SET FORTH HEREIN, SENSIRION MAKES NO WARRANTIES, EITHER EXPRESS OR IMPLIED, WITH RESPECT TO THE PRODUCT. ANY AND ALL WARRANTIES, INCLUDING WITHOUT LIMITATION, WARRANTIES OF MERCHANTABILITY OR FITNESS FOR A PARTICULAR PURPOSE, ARE EXPRESSLY EXCLUDED AND DECLINED.

SENSIRION is only liable for defects of this product arising under the conditions of operation provided for in the data sheet and proper use of the goods. SENSIRION explicitly disclaims all warranties, express or implied, for any period during which the goods are operated or stored not in accordance with the technical specifications.

SENSIRION does not assume any liability arising out of any application or use of any product or circuit and specifically disclaims any and all liability, including without limitation consequential or incidental damages. All operating parameters, including without limitation recommended parameters, must be validated for each customer's applications by customer's technical experts. Recommended parameters can and do vary in different applications.

SENSIRION reserves the right, without further notice, (i) to change the product specifications and/or the information in this document and (ii) to improve reliability, functions and design of this product.

Headquarters and Subsidiaries

Sensirion AG

Laubisruetistr. 50
CH-8712 Staefa ZH
Switzerland

phone: +41 44 306 40 00
fax: +41 44 306 40 30
info@sensirion.com
www.sensirion.com

Sensirion Taiwan Co. Ltd

phone: +886 2 2218-6779
info@sensirion.com
www.sensirion.com

Sensirion Inc., USA

phone: +1 312 690 5858
info-us@sensirion.com
www.sensirion.com

Sensirion Japan Co. Ltd.

phone: +81 45 270 4506
info-jp@sensirion.com
www.sensirion.com/jp

Sensirion Korea Co. Ltd.

phone: +82 31 337 7700~3
info-kr@sensirion.com
www.sensirion.com/kr

Sensirion China Co. Ltd.

phone: +86 755 8252 1501
info-cn@sensirion.com
www.sensirion.com/cn

To find your local representative, please visit
www.sensirion.com/distributors