

Datasheet – STS4xA

4th Gen., High-Accuracy, 16-bit, Automotive-Grade Temperature Sensor

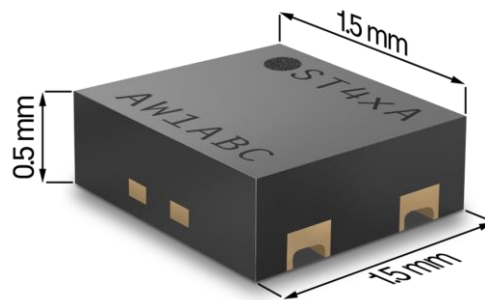

Highlights

- Temperature accuracy: up to $\pm 0.3\text{ }^{\circ}\text{C}$
- Supply voltage: 2.3 V ... 5.5 V
- I2C fast mode plus, CRC checksum
- Operating range: $-40\text{...}125\text{ }^{\circ}\text{C}$
- Designed for $85^{\circ}\text{C}/85\%\text{RH}$ reliability testing
- On-board diagnostics (OBD) capable
- AEC Q100 qualification, high-reliability design
- Mature technology from global market leader
- Wettable flanks package optional

The STS4xA is an automotive-grade digital sensor platform for measuring temperature with different accuracy gradings. It fulfills demanding reliability requirements for automotive applications, such as $85\text{ }^{\circ}\text{C}/85\text{ \%RH}$ accelerated life tests. The sensors can be interfaced via I2C. An integrated heater allows for advanced on-board-diagnostics while the sensor element is designed for reliable operation in harsh conditions. The four-pin dual-flat-no-leads package is suitable for surface mount technology (SMT) processing and can be ordered with a wettable flanks option.

Device Overview

Product	Details
STS41A-AW1B	0x44 I2C addr., wettable flanks

See full product list on page 14.

Functional Block Diagram

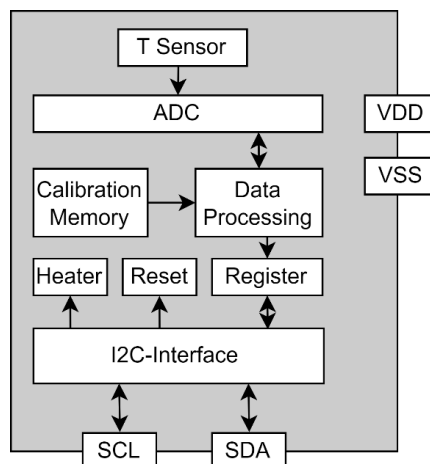

Scan me to provide feedback

Contents

1	Quick Start Guide.....	3
2	Sensor Specifications	4
2.1	Relative Humidity	4
3	Electrical Specifications	5
3.1	Electrical Characteristics	5
3.2	Timings.....	6
3.3	Absolute Maximum Ratings.....	6
4	Sensor Operation.....	7
4.1	I2C Communication.....	7
4.2	I2C Communication Timing	7
4.3	I2C Data type & length	7
4.4	I2C Checksum Calculation	7
4.5	I2C Command Overview.....	8
4.6	Conversion of Signal Output.....	8
4.7	Serial Number.....	9
4.8	Heater Operation	9
4.9	Reset.....	9
5	Physical Specification	10
5.1	Package Description.....	10
5.2	Packaging Outline- Package with Wettable Flanks	10
5.3	Land Pattern.....	10
5.4	Pin Assignment & Laser Marking	11
5.5	Thermal Information	12
6	Quality and Material Contents	13
7	Tape and Reel Packaging	13
8	Product Nomenclature	14
9	Ordering Information.....	14
	Revision History.....	14

1 Quick Start Guide

The STS4xA can be used in the same way as any SHT4xA, for which a typical application circuit is shown on the left-hand side of Figure 1. After reaching the minimal supply voltage and allowing for the maximal power-up time of 1 ms the sensor is ready for I2C communication. The quickest way to measure temperature is pseudo-coded on the right-hand side of Figure 1. Together with the conversion formulae given in equations (1) and (2) below, the digital signal can be translated into temperature readings.

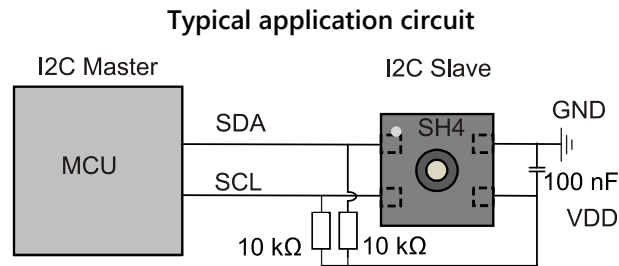

Pseudo code

```

i2c_write(i2c_addr=0x44, tx_bytes=[0xFD])
wait_seconds(0.01)
rx_bytes = i2c_read(i2c_addr=0x44,
number_of_bytes=3)
t_ticks = rx_bytes[0] * 256 + rx_bytes[1]
checksum_t = rx_bytes[2]
t_degC = -45 + 175 * t_ticks/65535 if (rh_pRH > 100):

```

Figure 1. Typical application circuit (top) and pseudo code (bottom) for easy starting with the I2C interface.

Find code resources and embedded drivers on: <https://github.com/Sensirion/embedded-sht/releases>



CAD files (outer dimensions of the STS4xA are identical to the SHT4xA except for removal of the sensor cavity) can be downloaded from SnapEDA ("*" considered as wildcard):

- [SHT4*A-*W*B](#)



2 Sensor Specifications

Every STS4xA is individually tested and calibrated and is identifiable by its unique serial number (see section 4.7 for details on the serial number). For the calibration, Sensirion uses transfer standards, which are subject to a scheduled calibration procedure. The calibration of the reference, used for the calibration of the transfer standards, is NIST traceable through an ISO/IEC 17025 accredited laboratory.

2.1 Relative Humidity

Parameter	Conditions	Value	Units
STS41A <i>T</i> Accuracy ¹	typ.	±0.3	°C
	max.	See Figure 2	-
Repeatability	high	0.04	°C
	medium	0.07	°C
	low	0.1	°C
Resolution ¹	-	0.01	°C
Specified range ²	-	-40 to +125	°C
Response time ³	$t_{63\%}$	2	s
Long-term drift ⁴	typ.	<0.03	°C/y

Table 1. General relative humidity sensor specifications.

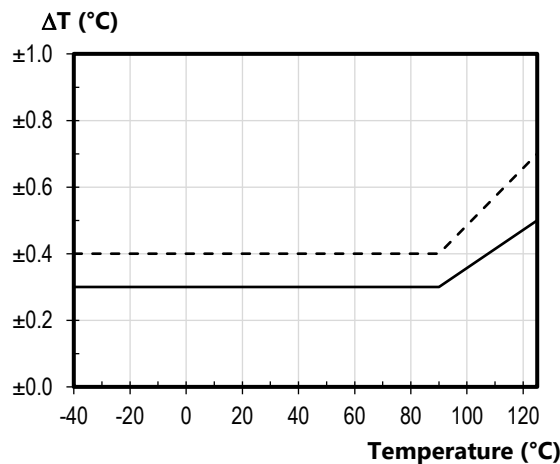

Figure 2. STS41A typical (solid) and maximal (dashed) temperature accuracy.

¹ Resolution of A/D converter.

² Specified range refers to the range for which the temperature sensor specification is guaranteed.

³ Time for achieving 63% of a step function, measured at 1 m/s airflow. Response time in the application depends on the design-in of the sensor.

⁴ Typical value for operation in normal operating range.

3 Electrical Specifications

Valid for all electrical specifications: Typical values correspond to $V_{DD} = 3.3\text{ V}$ and $T = 25\text{ °C}$. Min. and max. values are valid in the full temperature range $-40\text{ °C} \dots 125\text{ °C}$, at declared V_{DD} levels and are based on characterization.

3.1 Electrical Characteristics

Parameter	Symbol	Conditions	Min	Typ	Max	Unit	Comments
Supply voltage	V_{DD}		2.3	3.3	5.5	V	-
Power-up/down	V_{POR}	Static power supply	0.7	-	2.3	V	-
Supply current (heater off)	I_{DD}	Idle state	-	18	-	μA	-
		Measurement	-	320	500	μA	Average current consumption while sensor is measuring
		Avg., high repeatability Avg., med. repeatability Avg., low repeatability	- - -	20 19 18	- - -	μA	Avg. current consumption (continuous operation with at 1 Hz)
Low level input voltage	V_{IL}	-	0	-	$0.3^* V_{DD}$	V	-
High level input voltage	V_{IH}	-	$0.7^* V_{DD}$	-	V_{DD}	V	-
Pull up resistors	R_p	$V_{DD} < 3.0\text{ V}$	820	-	-	Ω	-
		$V_{DD} \geq 3.0\text{ V}$	390	-	-	Ω	-
Low level output voltage	V_{OL}	$V_{DD} \geq 2.3\text{ V}$, $R_{pullup} \geq 820\ \Omega$	-	-	0.4	V	-
		$V_{DD} \geq 3.0\text{ V}$, $R_{pullup} > 390\ \Omega$	-	-	0.4	V	-
Capacitive bus load	C_b	$R_p \geq 820\ \Omega$: fast mode	-	-	400	pF	Capac. bus load can be determined from $C_b < t_{rise}/(0.8473 \cdot R_p)$. Rise times are $t_{rise} = 300\text{ ns}$ for fast mode and $t_{rise} = 120\text{ ns}$ for fast mode plus
		$R_p \geq 390\ \Omega$, $V_{DD} \geq 3.0\text{ V}$: fast mode plus	-	-	340	pF	

Table 2. Electrical specifications.

3.2 Timings

Parameter	Symbol	Conditions	Min	Typ	Max	Unit	Comments
Power-up time	t_{PU}	After hard reset, $V_{DD} \geq V_{POR}$	-	0.3	1	ms	Time between V_{DD} reaching V_{POR} and sensor entering idle state
Soft reset time	t_{SR}	After soft reset	-	-	1	ms	Time between ACK of soft reset command and sensor entering idle state. Also valid for I2C general call reset.
Measurement duration	$t_{MEAS,l}$	Low repeatability	-	1.3	1.6	ms	The three repeatability modes differ with respect to measurement duration, noise level and energy consumption
	$t_{MEAS,m}$	Med. repeatability	-	3.7	4.5	ms	
	$t_{MEAS,h}$	High repeatability	-	6.9	8.3	ms	
Heater-on duration	t_{Heater}	Long pulse	0.81	1	1.19	s	After that time the heater is automatically switched off
		Short pulse	0.08	0.1	0.12	s	After that time the heater is automatically switched off

Table 3. System timing specifications.

3.3 Absolute Maximum Ratings

Stress levels beyond those listed in **Table 4**. Absolute maximum ratings. may cause permanent damage or affect the reliability of the device. These are stress ratings only and functional operation of the device at these conditions is not guaranteed. Ratings are only tested each at a time.

Parameter	Rating
Supply voltage VDD	-0.3 V ... 6.0 V
Max. voltage on any pin	$V_{SS} - 0.3 V \dots V_{DD} + 0.3 V$
Operating temperature range	-40 °C ... 125 °C
Storage temperature range	-40 °C ... 150 °C
ESD HBM	4 kV
ESD CDM	750 V
Latch-up, JESD78 Class II, 125°C	±100 mA

Table 4. Absolute maximum ratings.

4 Sensor Operation

4.1 I2C Communication

I2C communication is based on NXP’s I2C-bus specification and user manual UM10204, Rev.6, 4 April 2014. Supported I2C modes are standard, fast mode, and fast mode plus. Data is transferred in multiples of 16-bit words and 8-bit check sum (cyclic redundancy check = CRC). All transfers must begin with a start condition (S) and terminate with a stop condition (P). To finish a read transfer, send not acknowledge (NACK) and stop condition (P). Addressing a specific slave device is done by sending its 7-bit I2C address followed by an eighth bit, denoting the communication direction: “zero” indicates transmission to the slave, i.e. “write”, a “one” indicates a “read” request. Schematics of the I2C transfer types are sketched in **Figure 3**.

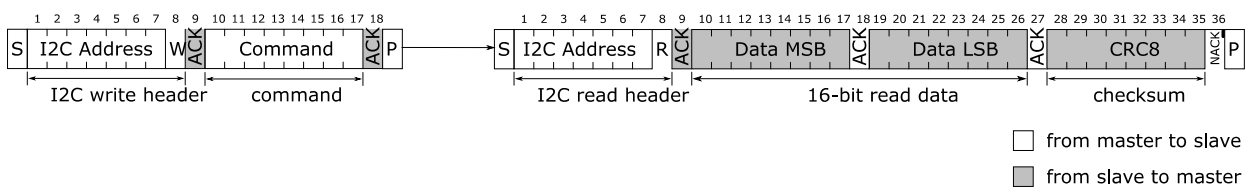

Figure 3. I2C transfer types: First a write header is sent to the I2C slave, followed by a command, for example “measure T with highest precision”. After the measurement is finished the read request directed to this I2C slave will be acknowledged and transmission of data will be started by the slave.

4.2 I2C Communication Timing

All details on the timing are following the interface specification of NXP’s user manual UM10204, Rev.6, 4 April 2014. Please follow mandatory capacitor and resistor requirements given in **Table 2**.

4.3 I2C Data type & length

I2C bus operates with 8-bit data packages. Information from the sensor to the master has a checksum after every second 8-bit data package. Temperature data will always be transmitted by 2 * 8-bit data + 8-bit CRC.

4.4 I2C Checksum Calculation

For read transfers each 16-bit data is followed by a checksum with the following properties

Parameter	Rating
Supply voltage VDD	-0.3 V ... 6.0 V
Max. voltage on any pin	VSS -0.3 V ... VDD +0.3 V
Operating temperature range	-40 °C ... 125 °C
Storage temperature range	-40 °C ... 150 °C
ESD HBM	4 kV
ESD CDM	750 V
Latch up, JEDEC Class II, 125°C	±100 mA

Table 5. Data Checksum properties

The master may abort a read transfer after the 16-bit data if it does not require a checksum.

4.5 I2C Command Overview

Command (hex)	Response length incl. CRC (bytes)	Description [return values]
0xFD	3	measure T with high precision (high repeatability) [2 * 8-bit T-data; 8-bit CRC]
0xF6	3	measure T with medium precision (medium repeatability) [2 * 8-bit T-data; 8-bit CRC]
0xE0	3	measure T with lowest precision (low repeatability) [2 * 8-bit T-data; 8-bit CRC]
0x89	6	read serial number [2 * 8-bit data; 8-bit CRC; 2 * 8-bit data; 8-bit CRC]
0x94	-	soft reset [ACK]
0x39	3	activate heater with 200mW for 1s, including a high precision measurement just before deactivation [2 * 8-bit T-data; 8-bit CRC]
0x32	3	activate heater with 200mW for 0.1s including a high precision measurement just before deactivation [2 * 8-bit T-data; 8-bit CRC]
0x2F	3	activate heater with 110mW for 1s including a high precision measurement just before deactivation [2 * 8-bit T-data; 8-bit CRC]
0x24	3	activate heater with 110mW for 0.1s including a high precision measurement just before deactivation [2 * 8-bit T-data; 8-bit CRC]
0x1E	3	activate heater with 20mW for 1s including a high precision measurement just before deactivation [2 * 8-bit T-data; 8-bit CRC]
0x15	3	activate heater with 20mW for 0.1s including a high precision measurement just before deactivation [2 * 8-bit T-data; 8-bit CRC]

Table 6. Overview of I2C commands. If the sensor is not ready to process a command, *e.g.* because it is still measuring, it will return NACK to the I2C read header. Given heater power values are typical and valid for VDD=5 V. At VDD=3.3 V, heating power is reduced

4.6 Conversion of Signal Output

The digital sensor signals correspond to following temperature values.

$$T = \left(-45 + 175 \cdot \frac{S_T}{2^{16} - 1} \right) ^\circ\text{C} \quad 1$$

$$T = \left(-49 + 315 \cdot \frac{S_T}{2^{16} - 1} \right) ^\circ\text{F} \quad 2$$

4.7 Serial Number

Every single sensor has a unique serial number, that is assigned by Sensirion during production. It is stored in the one-time-programmable memory and cannot be manipulated after production. The serial number is accessible via I2C and is transmitted as two 16-bit words, each followed by an 8-bit CRC.

4.8 Heater Operation

The sensor incorporates an integrated on-chip heater which can be switched on by the set of commands given in **Table 6**. There are three different heating powers and two different heating times accessible to the user. After reception of a heater-on command, the sensor executes the following procedure:

1. The heater is enabled, and the timer starts its count-down.
2. On timer expiration a temperature measurement with the highest repeatability is started, the heater remains enabled.
3. After the measurement is finished the heater is turned off.
4. Temperature are now available for readout.

The maximum on-time of the heater commands is 1 second in order to prevent overheating of the sensor by unintended usage of the heater. Thus, there is no dedicated command to turn off the heater. For extended heating periods it is required to send periodic heater-on commands, keeping in mind that the heater is designed for a maximal duty cycle of less than 10%. To obtain a fast increase in temperature the idle time between consecutive heating pulses shall be kept minimal.

Possible Heater Use Cases

The heater of the STS4xA can be used to enable OBD functionalities. Instead of checking only for sensor acknowledgement, sending a heater command and measuring the response gives an unmistakable indication of the sensor functionality. For this application, we encourage you to reach out to our experts and look forward to integrate this feature in your application with you.

Important notes for operating the heater:

1. The heater is designed for a maximum duty cycle of 10%, meaning the total heater-on-time should not be longer than 10% of the sensor's lifetime.
2. During operation of the heater, sensor specifications are not valid.
3. The temperature sensor can additionally be affected by the thermally induced mechanical stress, offsetting the temperature reading from the actual temperature.
4. The sensor's temperature (base temperature + temperature increase from heater) must not exceed $T_{max} = 125\text{ °C}$ to have proper electrical functionality of the chip.
5. The heater draws a large amount of current once enabled (up to ~50 mA in the highest power setting). Although a dedicated circuitry draws this current smoothly, the power supply must be strong enough to avoid large voltage drops that could provoke a sensor reset.
6. If higher heating temperatures are desired, consecutive heating commands can be sent to the sensor. To keep times between consecutive heating pulses minimal, polling of the sensor is advised. The heater shall only be operated in ambient temperatures below 65 °C else it could drive the sensor outside of its maximal operating temperature.

4.9 Reset

A reset of the sensor can be achieved in three ways:

- I2C Soft reset: send the reset command described in **Table 6**.
- I2C general call: all devices on I2C bus are reset by sending the command 0x06 to the I2C address 0x00.
- Power down (incl. pulling SCL and SDA low)

5 Physical Specification

5.1 Package Description

STS4xA is provided in a dual flat no lead (DFN) package with wettable flanks. The sensor chip is made of silicon, hosted on a copper lead frame and overmolded by an epoxy-based mold compound. Exposed bottom side of the leadframe with the metallic contacts is Ni/Pd/Au coated, side walls are bare copper. Moisture sensitivity level (MSL) of 1 according to IPC/JEDEC J-STD-020 is achieved. It is recommended to process the sensors within one year after date of delivery.

5.2 Packaging Outline- Package with Wettable Flanks

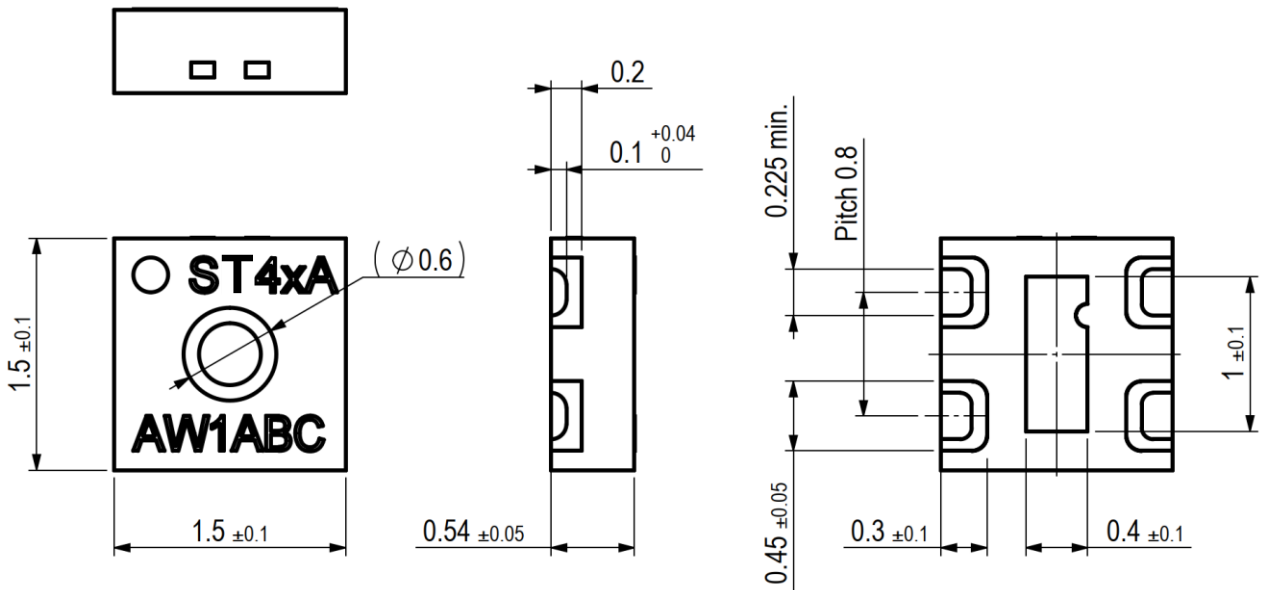

Figure 4. Dimensional drawing of STS4xA with wettable flanks, including package tolerances (units mm).

5.3 Land Pattern

The land pattern is recommended to be designed according to the used PCB and soldering process together with the physical outer dimensions of the sensor. For reference, the land pattern used with Sensirion's PCBs and soldering processes is given in **Figure 5**. Sensirion recommends to not solder the central die pad because the sensor can reach higher temperatures upon heater activation.

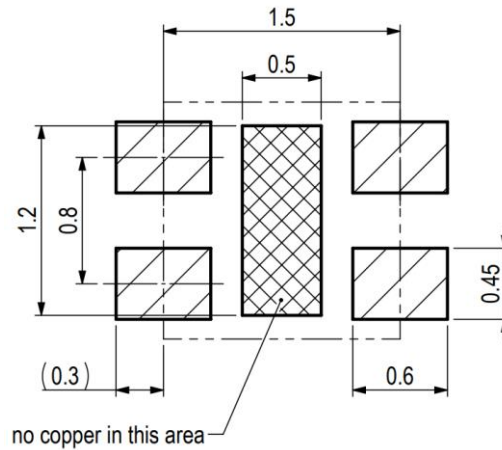

Figure 5. Recommended land pattern (in mm). Details can vary and depend on used PCBs and solder processes. There shall be no copper under the sensor other than at the pin pads.

5.4 Pin Assignment & Laser Marking

Pin	Name	Comments
1	SDA	Serial data, bidirectional
2	SCL	Serial clock, unidirectional input
3	VDD	Supply voltage
4	VSS	Ground

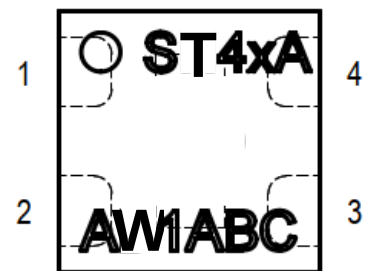

Figure 6 Pin assignment (transparent top view). Dashed lines are only visible if the sensor is viewed from below. The die pad is not directly connected to any pin.

The laser marking consists of two lines, indicated in **Figure 6**. In the first line a filled circle serves as pin-1 indicator and is followed by "ST4". The fourth character will indicate the accuracy class of this product (here "x" serves as place holder). Last "A" indicates the automotive grade. In the second line, the first three characters specify the product characteristics according to positions 8, 9 and 10 of Table 8. The second three characters serve as internal batch tracking code.

5.5 Thermal Information

Symbol	Description	Heater off, die pad soldered (K/W)		Heater on, die pad soldered (K/W)		Heater off, die pad not solder. (K/W)		Heater on, die pad not solder. (K/W)	
		DFN	DFN+WF	DFN	DFN+WF	DFN	DFN+WF	DFN	DFN+WF
$R_{\theta JA}$	Junction-to-ambie. thermal resistance	246	258	308	329	297	322	357	390
$R_{\theta JC}$	Junction-to-case thermal resistance	189	183	255	252	191	188	257	254
$R_{\theta JB}$	Junction-to-board thermal resistance	159	177	225	242	193	219	258	284
Ψ_{JB}	Junction-to-board characteriz. param.	159	171	223	242	191	213	254	282
Ψ_{JT}	Junction-to-top characteriz. param.	38	35	105	104	44	42	112	111

Table 7. Typical values for thermal metrics. In the “heater on” columns a heater power of 200 mW was assumed. Soldering of the die pad is not recommended, therefore the two right hand side columns are bold. The sub-columns labelled “DFN+WF” display the results for the DFN package with soldered wettable flanks terminals. Values are based on simulation.

6 Quality and Material Contents

Qualification of STS4xA is performed based on the AEC Q100 qualification test method. Qualification pending. The device is fully RoHS and WEEE compliant, e.g. free of Pb, Cd, and Hg.

7 Tape and Reel Packaging

All specifications for the tape and reel packaging can be found on **Figure 7**. Reel diameters are 13 inch and 8 inch for the 10k and the 2.5k packaging sizes, respectively.

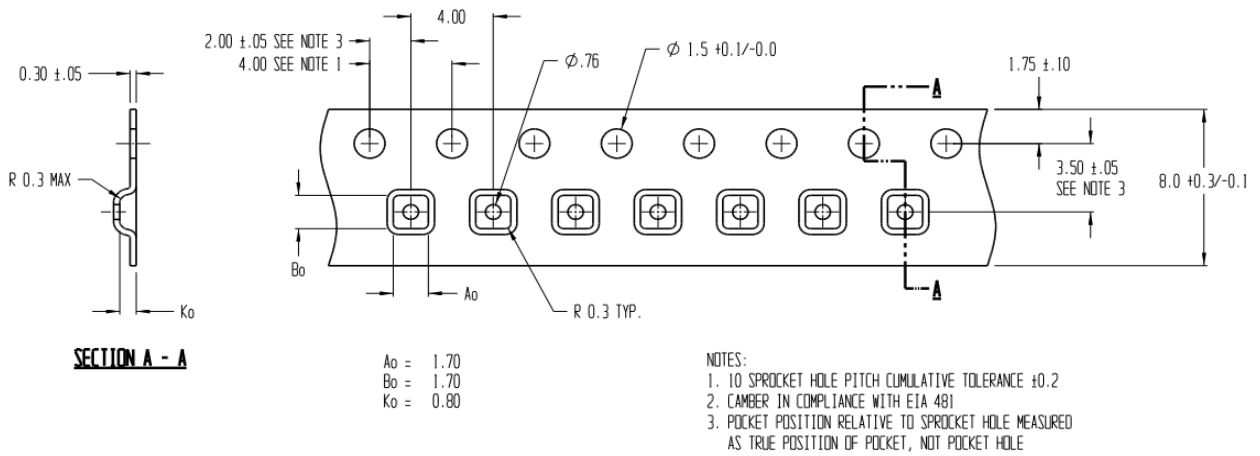

Figure 7. Tape and reel specifications including sensor orientation in pocket (see indication of two sensors on the right side of the tape).

8 Product Nomenclature

Position	Value(s)	Explanation
1	S	Sensirion
2	T	Temperature Signal
3	S	Sensor
4	4	Fourth product generation
5	1	±0.2 °C
6	A	automotive version
7	-	delimiter
8	A	I2C interface with 0x44 address
9	W	DFN package with wettable flanks
10	1	Reserved
11	B	Blank package
12	-	delimiter
13	R	Tape on reel packaging
14	2 3	Packaging article contains 2'500 pieces Packaging article contains 10'000 pieces

Table 8. STS4xA product nomenclature.

9 Ordering Information

Material Description	Material Number	Details	Quantity (pcs)
STS41A-AW1B-R2	3.000.692	improved T accuracy, 0x44 I2C addr., wetable flanks	2'500
STS41A-AW1B-R3	tbd	improved T accuracy, 0x44 I2C addr., wetable flanks	10'000

Table 9. STS4xA ordering options.

Revision History

Date	Version	Page(s)	Changes
August 2022	1	All	First release
Mai 2023	2	All 10 14	Reformatting Showing only package outline with wettable Flanks Updated Table 9: only Wettable-flanks option available

Important Notices

Warning, Personal Injury

Do not use this product as safety or emergency stop devices or in any other application where failure of the product could result in personal injury. Do not use this product for applications other than its intended and authorized use. Before installing, handling, using or servicing this product, please consult the data sheet and application notes. Failure to comply with these instructions could result in death or serious injury.

If the Buyer shall purchase or use SENSIRION products for any unintended or unauthorized application, Buyer shall defend, indemnify and hold harmless SENSIRION and its officers, employees, subsidiaries, affiliates and distributors against all claims, costs, damages and expenses, and reasonable attorney fees arising out of, directly or indirectly, any claim of personal injury or death associated with such unintended or unauthorized use, even if SENSIRION shall be allegedly negligent with respect to the design or the manufacture of the product.

ESD Precautions

The inherent design of this component causes it to be sensitive to electrostatic discharge (ESD). To prevent ESD-induced damage and/or degradation, take customary and statutory ESD precautions when handling this product. See application note "ESD, Latchup and EMC" for more information.

Warranty

SENSIRION warrants solely to the original purchaser of this product for a period of 12 months (one year) from the date of delivery that this product shall be of the quality, material and workmanship defined in SENSIRION's published specifications of the product. Within such period, if proven to be defective, SENSIRION shall repair and/or replace this product, in SENSIRION's discretion, free of charge to the Buyer, provided that:

- notice in writing describing the defects shall be given to SENSIRION within fourteen (14) days after their appearance;
- such defects shall be found, to SENSIRION's reasonable satisfaction, to have arisen from SENSIRION's faulty design, material, or workmanship;
- the defective product shall be returned to SENSIRION's factory at the Buyer's expense; and
- the warranty period for any repaired or replaced product shall be limited to the unexpired portion of the original period.

This warranty does not apply to any equipment which has not been installed and used within the specifications recommended by SENSIRION for the intended and proper use of the equipment. EXCEPT FOR THE WARRANTIES EXPRESSLY SET FORTH HEREIN, SENSIRION MAKES NO WARRANTIES, EITHER EXPRESS OR IMPLIED, WITH RESPECT TO THE PRODUCT. ANY AND ALL WARRANTIES, INCLUDING WITHOUT LIMITATION, WARRANTIES OF MERCHANTABILITY OR FITNESS FOR A PARTICULAR PURPOSE, ARE EXPRESSLY EXCLUDED AND DECLINED.

SENSIRION is only liable for defects of this product arising under the conditions of operation provided for in the data sheet and proper use of the goods. SENSIRION explicitly disclaims all warranties, express or implied, for any period during which the goods are operated or stored not in accordance with the technical specifications.

SENSIRION does not assume any liability arising out of any application or use of any product or circuit and specifically disclaims any and all liability, including without limitation consequential or incidental damages. All operating parameters, including without limitation recommended parameters, must be validated for each customer's applications by customer's technical experts. Recommended parameters can and do vary in different applications.

SENSIRION reserves the right, without further notice, (i) to change the product specifications and/or the information in this document and (ii) to improve reliability, functions and design of this product.

Headquarters and Subsidiaries

Sensirion AG

Laubisruetistr. 50
CH-8712 Staefa ZH
Switzerland

phone: +41 44 306 40 00
fax: +41 44 306 40 30
info@sensirion.com
www.sensirion.com

Sensirion Taiwan Co. Ltd

phone: +886 2 2218-6779
info@sensirion.com
www.sensirion.com

Sensirion Inc., USA

phone: +1 312 690 5858
info-us@sensirion.com
www.sensirion.com

Sensirion Japan Co. Ltd.

phone: +81 45 270 4506
info-jp@sensirion.com
www.sensirion.com/jp

Sensirion Korea Co. Ltd.

phone: +82 31 337 7700~3
info-kr@sensirion.com
www.sensirion.com/kr

Sensirion China Co. Ltd.

phone: +86 755 8252 1501
info-cn@sensirion.com
www.sensirion.com/cn

To find your local representative, please visit
www.sensirion.com/distributors